

ARISTA

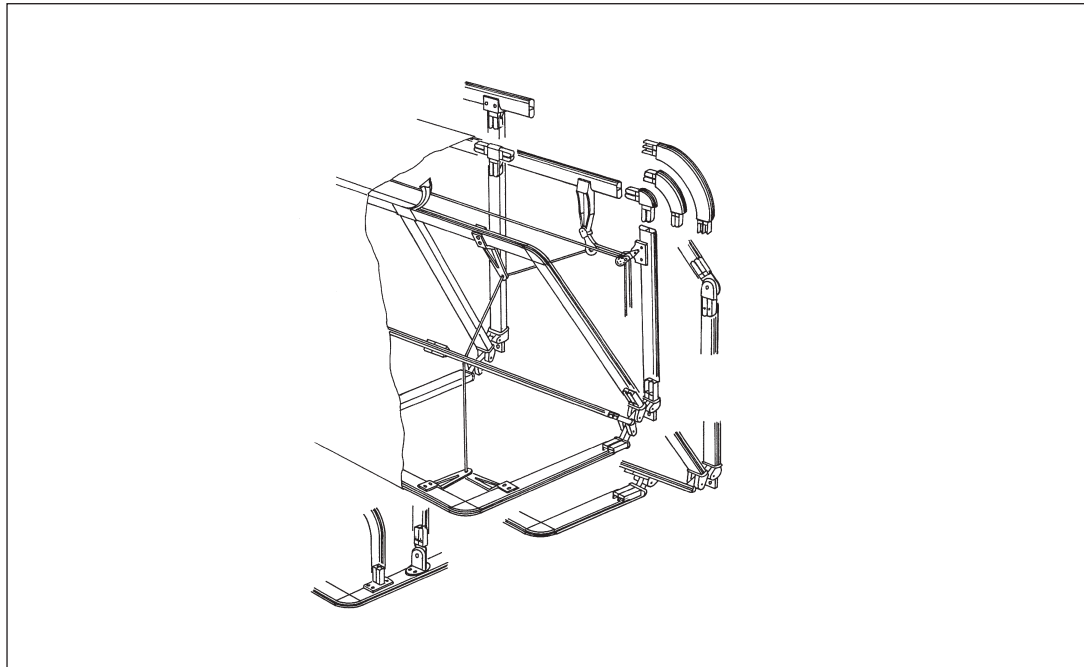

DUTCH CANOPY COMPONENT BOOK

INDEX

	Page
Beskrivning Description Beschreibung	2-5
Sprängskiss Exploded view Explosionsdarstellung	6
Komponenter Components Komponenten	7-15
Handverktyg Handtools Handwerkzeuge	16
Korsreferens Cross reference Zubehör	17
Kapmått Fabrication guidelines Abschneidemaße	18
Materialkalkyl Bill of material Komponenten Aufstellung	19-20
Modeller Models Modelle	21

FÖRKLARINGAR

* efter ett artikelnummer hänvisar till rekommenderad skruv etc.

EXPLANATIONS

* after an article number refers to recommended screw etc.

ERKLÄRUNGEN

* nach einer Bestellnummer weist auf empfohlene Schraube hin, usw.

Beskrivning

Användningsområde

Arista är en extra kraftig korgmarkis för de flesta byggnader, t ex villor, kontor och butiker.

Arista kan tillverkas i många olika varierande modeller och lämpar sig mycket väl för tillverkning av baldakiner.

Manövrering

Utvändig manövrering med lina, växel eller motor.

Invändig manövrering med motor. Motorn kan kompletteras med automatiska styrningar, t ex fjärrkontroll eller sol- och vindautomatik.

Montering

Markisen monteras ovanför fönster eller över entréer.

Komponenter

Gångjärn, beslag och hörnbågar är tillverkade av pressgjutet aluminium. Den löstagbara veven i stål är pulverlackerad. Obehandlade eller galvaniserade artiklar har färgnummer 0000.

Fästelement är tillverkade av rostfritt stål, förzinkat stål eller ytbehandlat med Dacro. 500 LC.

Profiler

Profiler till bågar är tillverkade av strängpressat aluminium. Naturanodiserade aluminiumprofiler har färgnummer 0000 och obehandlade 0100.

Dimensioner

Utfall: 0.4 – 2.0 m.

Max. bredd 6.0 m per enhet.

Ovanstående mått är rekommenderade maxmått som inte bör överskridas. Vid svåra monteringsförhållanden bör även dessa maxmått övervägas.

Icke standard artiklar

Artikelnummer markerade med "Nonstandard" lagerförs inte och har därför längre leveranstid. Minsta orderkvantitet (Min) gäller.

Vi förbehåller oss rätten till konstruktionsändringar.

Description

Range of application

Arista is a heavy-duty Dutch canopy for most buildings, e.g. restaurants, kiosks, shops, hotels, offices and villas. Arista can be produced in many different models and is suitable also for walkways.

Operation

Exterior operation with cord, gear or motor. Interior operation with motor. The motor can be completed with automatic controls, for example remote control or sun and wind sensors.

Installation

The awning can be installed above windows or over entrances.

Components

Hinges, fittings and hoop corners are manufactured of die-cast aluminium. The removable crank handle is powder coated. Untreated or galvanised articles have colour code 0000.

Fasteners are manufactured of stainless steel, zinc plated steel or surface treated with Dacro. 500 LC.

Profiles

Canopy hoops are manufactured of extruded aluminium. Clear anodised profiles have colour code 0000 and untreated 0100.

Dimensions

Projection 0.4 – 2.0 m (1'4" – 6'7").
Max width 6.0 m (19'8") per unit.

The maximum measurements are recommended and should not be exceeded. If the installation conditions are difficult, even these dimensions should be reconsidered.

Nonstandard articles

Articles marked with "Nonstandard" are not kept in stock, which results in longer delivery times. Minimum order quantities (Min) apply.

Subject to changes without notice.

Beschreibung

Einsatzgebiete

Arista ist eine sehr robuste Korbmarkise für die meisten Gebäude, z.B. an Villen, Schulen, Büros, Krankenhäusern usw. geeignet sind. Arista kann jedem Stil des Hauses angepasst werden und lässt keine Wünsche offen, bis hin zum Baldachin.

Bedienung

Die Bedienung von außen erfolgt wahlweise mittels Handkurbel, Schnur oder Motor, von innen mittels Motor. Für den Motor sind automatische Steuerungen, z.B. Fernbedienung oder Sonnen- und Windautomatik erhältlich.

Montage

Die Markise kann über Fenster oder Overeingänge angebracht werden.

Komponenten

Scharniere, Befestigungen und Bandoecken sind aus Aluminium Hochdruckguss. Die abnehmbare Handkurbel ist aus Stahl ist pulverbeschichtet. Unbehandelte oder galvanisierte Teile haben die Farbenbezeichnung 0000.

Die Befestigungsteile sind aus rostfreiem Stahl, verzinktem Stahl oder mit Dacrolit 500 LC gefertigt.

Profile

Spiegelprofil, Kupplungsprofil und Schnurführungsprofil sind aus stranggepresstem Aluminium. Natureloxierte Aluminiumprofile haben Farbenbezeichnung 0000 und unbeschichtete 0100.

Maße

Ausfall: 0.4 – 2.0 Mtr.

Max. Breite: 6.0 Mtr.

Diese Maximalmaße sind empfohlen und sollten nicht überschritten werden. Bei schwierigen Montagebedingungen sollten auch diese Max.-Maße überdacht werden.

Nonstandard Artikel

Bestell-Nr., die mit der Kennung „Nonstandard“ ausgeschrieben sind, werden nicht auf Lager. Daher verlängert sich bei diesen Artikeln die Lieferzeit. Auch Mindestbestellmengen sind erforderlich.

Technische Änderungen vorbehalten

Exploded view Arista

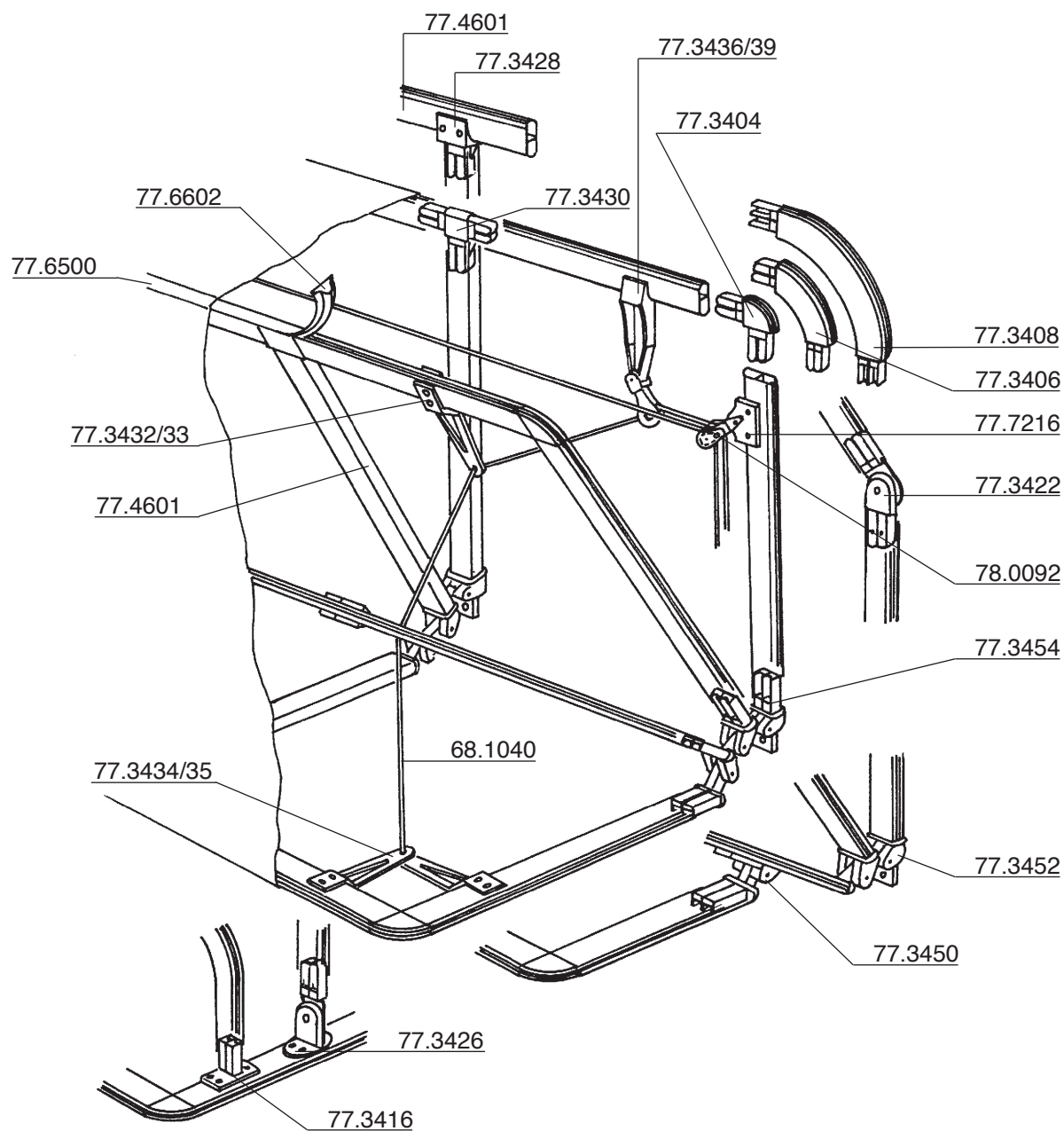

Artikel nr utan färgnummer
Article No. without colour number
Bestell-Nr. ohne Farbenbezeichnung

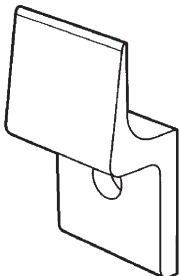
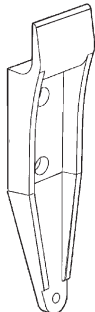
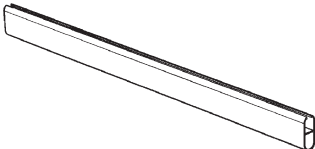
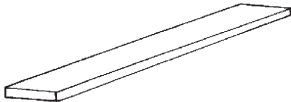
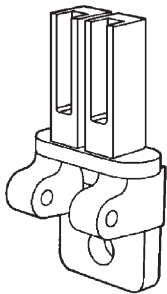

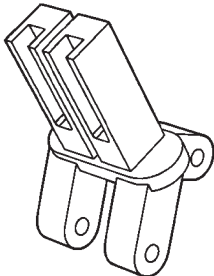
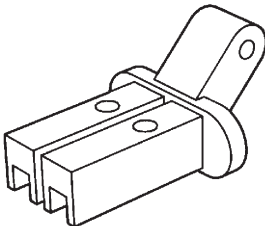
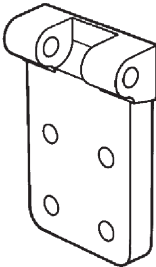
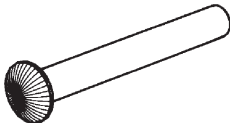
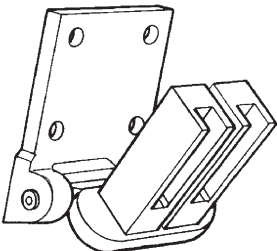
	Article No.	Description	Note	Stand. pack
	77.3402.0000	Installation bracket Aluminium Monteringskonsol Aluminium Wandträger Aluminium		50
	77.3436.0000 77.3439.0000	Installation bracket and holder for cord wheel Aluminium Monteringskonsol och hållare för linhjul Aluminium Wandträger und Halter für Blockrolle Aluminium	L 140 mm (5 1/2") L 248 mm (9 3/4")	5 5
	77.4601.0000	Base profile Aluminium Basprofil Aluminium Spiegelprofil Aluminium		45 x 18 mm 15 x 6m 90 m
	77.4608.0000	Strengthening profile Aluminium, for fixed canopy hoops Förstärkningsprofil Aluminium, för fasta bågar Verstärkungsprofil Aluminium, für feste Bogen	(19'8")	25 x 5 mm 6 m
	77.3410.0000	Base hinge Aluminium Basgångjärn Aluminium Scharnier, Anfang Aluminium		50

	Article No.	Description	Note	Stand. pack
	77.3412.0000	<p>Centre hinge Aluminium</p> <p>Mellångångjärn Aluminium</p> <p>Scharnier, Mittelstück Aluminium</p>		100
	77.3414.0000	<p>Front hinge Aluminium</p> <p>Slutgångjärn Aluminium</p> <p>Scharnier, Endstück Aluminium</p>		50
	77.3418.0000	<p>Base hinge Profile mounting Aluminium, for front hinge 77.3414</p> <p>Basgångjärn Klättrande bågar Aluminium, för slutgångjärn 77.3414</p> <p>Scharnier, Profilmontage Aluminium, für Scharnier, Endstück 77.3414</p>		20
	66.6202.0000	<p>Hinge bolt Aluminium</p> <p>Gångjärnsnit Aluminium</p> <p>Scharnierbolzen Aluminium</p>	5x40 mm	100
	77.3450.0000	<p>Hinge 1 canopy hoops Aluminium, for profile mounting</p> <p>Gångjärn 1-båge Aluminium, för klättrande bågar</p> <p>Scharnier 1 Boge Aluminium, für Profilmontage</p>		10

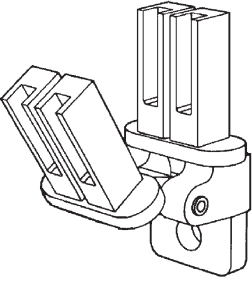
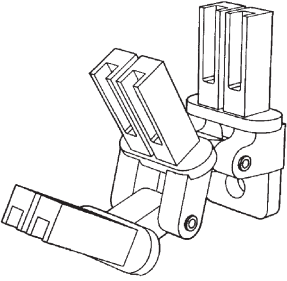
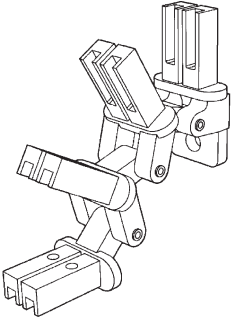
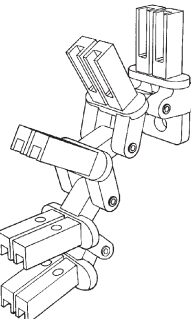
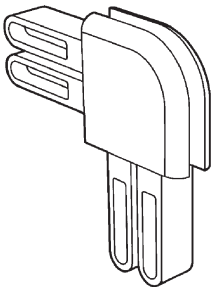

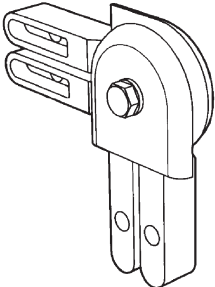
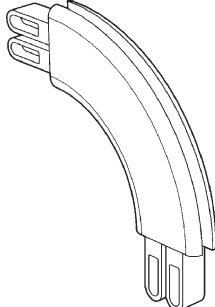
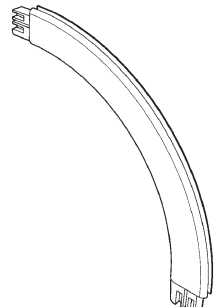
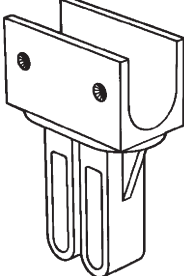
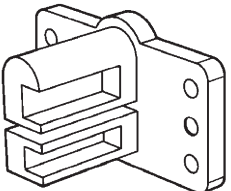

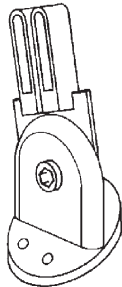
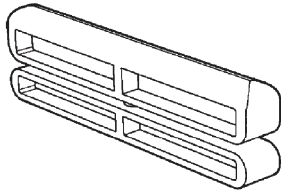
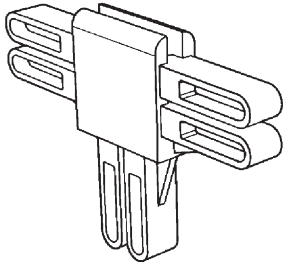
Article No.	Description	Note	Stand. pack
	<p>Hinge 2 canopy hoops Aluminium</p> <p>Gångjärn 2-bågar Aluminium</p> <p>Scharnier 2 Bogen Aluminium</p>	<p>77.3452.0000</p> <p>Non-stock item, min qty 10 pcs</p>	<p>10</p>
	<p>Hinge 3 canopy hoops Aluminium</p> <p>Gångjärn 3-bågar Aluminium</p> <p>Scharnier 3 Bogen Aluminium</p>	<p>77.3453.0000</p> <p>Non-stock item, min qty 10 pcs</p>	<p>10</p>
	<p>Hinge 4 canopy hoops Aluminium</p> <p>Gångjärn 4-bågar Aluminium</p> <p>Scharnier 4 Bogen Aluminium</p>	<p>77.3454.0000</p> <p>Non-stock item, min qty 10 pcs</p>	<p>10</p>
	<p>Hinge 5 canopy hoops Aluminium</p> <p>Gångjärn 5-bågar Aluminium</p> <p>Scharnier 5 Bogen Aluminium</p>	<p>77.3455.0000</p> <p>Non-stock item, min qty 10 pcs</p>	<p>10</p>
	<p>Fixed corner Aluminium, radius 25 mm</p> <p>Fast hörn Aluminium, radie 25 mm</p> <p>Eckverbinder Aluminium, Radius 25 mm</p>	<p>77.3404.0000</p>	<p>45 x 18 mm</p> <p>50</p>

	Article No.	Description	Note	Stand. pack
	77.3422.0000	<p>Adjustable corner Aluminium, radius 25 mm</p> <p>Ställbart hörn Aluminium, radie 25 mm</p> <p>Eckverbinder, einstellbar Aluminium, Radius 25 mm</p>	90°-180°	10
	77.3406.0000	<p>Fixed corner Aluminium, radius 100 mm</p> <p>Fast hörn Aluminium, radie 100 mm</p> <p>Eckverbinder Aluminium, Radius 100 mm</p>	45 x 18 mm	10
	77.3408.0000	<p>Fixed corner Aluminium, radius 250 mm</p> <p>Fast hörn Aluminium, radie 250 mm</p> <p>Eckverbinder Aluminium, Radius 250 mm</p>	45 x 18 mm	10
	77.3428.0000	<p>Centre support bracket Aluminium, for base profile 77.4601</p> <p>Mittstödsconsol Aluminium, för basprofil 77.4601</p> <p>Mittelstütze Aluminium, für Spriegelprofil 77.4601</p>		10
	77.3416.0000	<p>Profile connector Aluminium, for base profile 77.4601</p> <p>Profilförbindelse Aluminium, för basprofil 77.4601</p> <p>Profilverbindung Aluminium, für Spriegelprofil 77.4601</p>		10

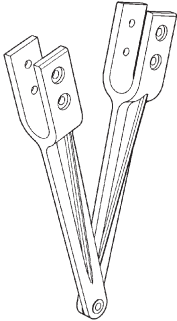
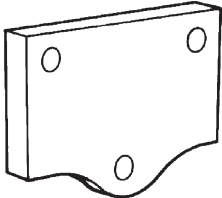
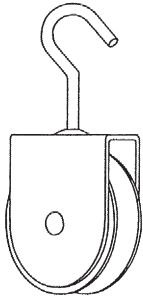
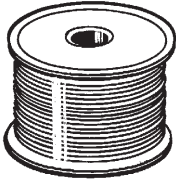
	Article No.	Description	Note	Stand. pack
	77.3426.0000	Profile connector, adjustable Aluminium, for base profile 77.4601 Profilförbindelse, justerbar Aluminium, för basprofil 77.4601 Profilverbindung, einstellbar Aluminium, für Spriegelprofil 77.4601	90°-180°	50
	77.3420.0000	Joining piece Aluminium, for base profile 77.4601 Skarvstycke Aluminium, för basprofil 77.4601 Kupplung Aluminium, für Spriegelprofil 77.4601		5
	77.3430.0000	T-piece Aluminium, for base profile 77.4601 T-stycke Aluminium, för basprofil 77.4601 T-Stück Aluminium, für Spriegelprofil 77.4601		5
	77.3432.0000 77.3433.0000	Cord guide, single Aluminium Linstyrning, enkel Aluminium Schnurführung, einfach Aluminium	L 140 mm (5 1/2") L 216 mm (8 1/2")	5 5

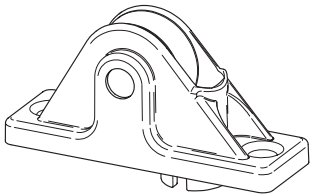
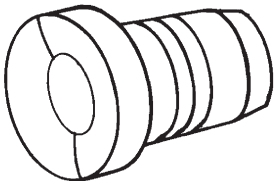
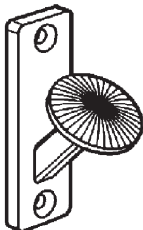

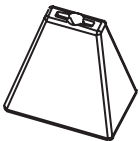
	Article No.	Description	Note	Stand. pack
	<p>77.3434.0000 77.3435.0000</p>	<p>Cord guide, double Aluminium</p> <p>Linstyrning, dubbel Aluminium</p> <p>Schnurführung, doppel Aluminium</p> <p>L 140 mm (5 1/2") L 216 mm (8 1/2")</p>		<p>5 5</p>
	<p>77.7216.0000</p>	<p>Fixing plate for cord wheel Steel, zinc plated</p> <p>Fästplatta för linhjul Stål, förzinkad</p> <p>Halbeplatte für Blockrolle Stahl, verzinkt</p>		<p>10</p>
	<p>78.0092.0000</p>	<p>Cord wheel POM and steel, zinc plated</p> <p>Linhjul POM och stål, förzinkad</p> <p>Blockrolle POM und Stahl, verzinkt</p>		<p>50</p>
	<p>68.1040.5000</p>	<p>Cord Polyester, with centre core</p> <p>Lina Polyester, med kärna</p> <p>Aufzugschnur Polyester, mit Einlage</p> <p>Vit White Weiss</p>	<p>K 40</p>	<p>130 m</p>

	Article No.	Description	Note	Stand. pack
	77.7210.0001	Cord guide Plastic Brytbeslag Plast Schnurbeslag Kunststoff * 66.1086	Vit White Weiss	10
	77.7212.0000	Cord inlet Steel, nickel plated Lingenomföring Stål, förnicklad Durchführung für Schnur Stahl, glanzverzinkt		10
	77.3304.0000	Cleat Zinc Knap Zink Seilverschluss Zink		25
	77.6730.0058	Cleat Polyamide Knap Polyamid Seilverschluss Polyamid * 66.1086	Silver Silber	25
	71.2301.0001 71.2301.0182	Tassel ABS, for tape and cord Bandknopp ABS, för band och lina Quaste ABS, für Band und Schnur	Vit White Weiss Silver Silber	100 100

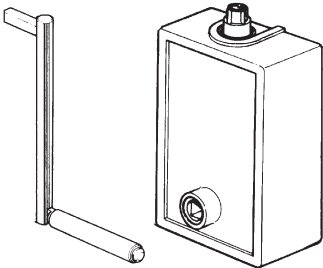
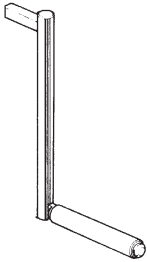
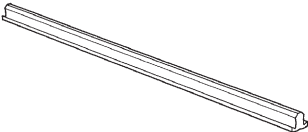

	Article No.	Description	Note	Stand. pack
	<p>77.9310.0001</p>	<p>Crank box with crank handle Complete, 2:1, installed internally</p> <p>Vevbox med vev Komplett, 2:1, monteras invändigt</p> <p>Kurbelkasten mit Handkurbel Komplett, 2:1, für innen montage</p> <p>* 66.1088</p>	<p>86 x 121 x 44 mm</p> <p>Max 40 kg</p>	<p>1</p>
	<p>77.9322.0001</p>	<p>Crank handle Spare part for crank box with crank handle 77.9310</p> <p>Vev Reservdel för vevbox med vev 77.9310</p> <p>Handkurbel Erzatzteil für Kurbelkasten mit Handkurbel 77.9310</p>		<p>1</p>
	<p>77.6602.0000</p>	<p>Filling profile PVC</p> <p>Fästlist PVC</p> <p>Nagel-Keder PVC</p>	<p>Beige</p>	<p>50 m</p>

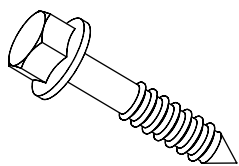

	Article No.	Description	Note	Stand. pack
		Decoration profile PVC		
		Dekorlist PVC		
		Zierprofil PVC		
	77.6500.0005	Mörkgrön Dark green, Non-stock item, min qty 200 m		200 m
	77.6500.0011	Röd Red, Non-stock item, min qty 200 m		200 m
	77.6500.0012	Gul Yellow, Non-stock item, min qty 200 m		200 m
	77.6500.0013	Blå Blue, Non-stock item, min qty 200 m		200 m
	77.6500.0014	Mörkbeige Dark beige, Non-stock item, min qty 200 m		200 m
	77.6500.0015	Vit White, Non-stock item, min qty 200 m		200 m
	77.6500.0024	Svart Black, Non-stock item, min qty 200 m		200 m
	77.6500.0052	Beige, Non-stock item, min qty 200 m		200 m
	77.6500.0054	Ockra Ochre, Non-stock item, min qty 200 m		200 m
	77.6500.0073	Vinröd Vinered, Non-stock item, min qty 200 m		200 m
	77.6500.0075	Marinblå Navy blue, Non-stock item, min qty 200 m		200 m
	77.6500.0079	Grå Grey, Non-stock item, min qty 200 m		200 m
	77.6500.0081	Brun Brown, Non-stock item, min qty 200 m		200 m
	77.6500.0084	Rost Rust, Non-stock item, min qty 200 m		200 m
77.6500.0151	Krämvit Off-white, Non-stock item, min qty 200 m		200 m	
		Plastic hose Polyethylene, for packaging of components		
		Plastslang Polyeten, för emballering av komponenter		
		Kunststoffschlauch Polyäthylenen, zum verpacken der Komponenten		
	77.9900.0000	(1640ft) W 0.23 m (9"), Thickness 0.10 mm		500 m
	77.9901.0000	(1640') W 0.5m (1'7"), Thickness 0.10 mm		500 m
		Screw for installation Steel, Protect 4	Spanner 8 mm	
		Monteringskruv Stål, Protect 4		
		Befestigungsschraube Stahl, Protect 4		
	66.1203.0000		6x40	100

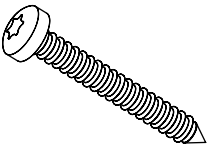
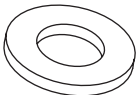

	Article No.	Description	Note	Stand. pack
	66.1201.0000	Screw for installation Steel, Protect 4 Monteringskruv Stål, Protect 4 Befestigungsschraube Stahl, Protect 4	TRT (Torx)	200
		4x30		
	66.1100.0000	Washer Stainless steel Bricka Rostfritt stål Unterlegscheibe Edelstahl rostfrei	6.7x14x1.5	100
	66.1108.0000		8.4x16x1.5	100

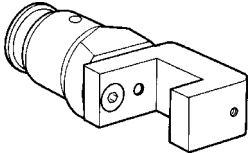
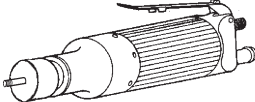
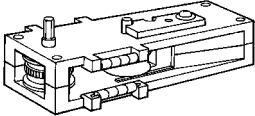
Article No.	Description	Note	Stand. pack
	<p>Stamping tool For profile 77.4601/02/04, Requires power unit 89.8001</p>	<p>Arista</p>	
<p>89.8052.0000</p>			
	<p>Power unit Without tool</p>	<p>Aruba, Siesta, Sienna, Arista, Ronda, Venezia</p>	
<p>89.8001.0000</p>			
	<p>Assembly tool For mounting of filling profile 77.6602</p>	<p>Arista</p>	
<p>90.8050.0000</p>			

Cross reference

Description	Article No.	Articles for assembly	Quantity
Installation of brackets		66.1203	1

Fabrication guidelines Arista

Number of hoops per projection

Projection	Hoops	
	Type A	Type B
	[PCS]	[PCS]
≤ 900 mm (3')	4	4
≤ 1000 mm (3'4")	5	4
≤ 1300 mm (4'3")	5	5
≤ 1500 mm (4'11")	6	5
≤ 1600 mm (5'3")	6	6
≤ 2000 mm (6'7")	7	6

Number of installation brackets and centre arms per awning width for type A and B

Width	Installation brackets	Centre arms
	[PCS]	[PCS]
≤ 1600 mm (5'3")	2	0
≤ 2800 mm (9'2")	3	0
≤ 3500 mm (11'6")	4	0
≤ 4500 mm (14'9")	5	1
≤ 6000 mm (19'8")	6	1

For projections over 1200 mm (3'11") installation brackets should be used also on the vertical profiles of the wall hoop

Bill of material: Arista type A with cord operation

Projection: 800 mm

Width: 2000 mm

Number of hoops: 3

Description	Colour	Qty			Unit	Stand. Pack [Unit]
		Model A25	Model A100	Model A250		
Base profile	77.4601.0000	10,8	10,2	9,3	m	90
Filling profile	77.6602.0000	12,0	12,0	12,0	m	50
Decoration profile	77.6500.xxxx	12,0	12,0	12,0	m	200
Installation bracket	77.3402.0000	3	3	3	PCS	50
Screw for installation	66.1203.0000	3	3	3	PCS	100
Hinge 3 canopy hoops	77.3453.0000	2	2	2	PCS	10
Fixed corner 25 mm	77.3404.0000	6	-	-	PCS	50
Fixed corner 100 mm	77.3406.0000	-	6	-	PCS	10
Fixed corner 250 mm	77.3408.0000	-	-	6	PCS	10
Cord guide, single	77.3433.0000	3	3	3	PCS	5
Cord wheel	78.0092.0000	2	2	2	PCS	20
Fixing plate for cord wheel	77.7216.0000	1	1	1	PCS	10
Cord cleat	77.3304.0000	1	1	1	PCS	25
Tassel	71.2301.0058	1	1	1	PCS	100
Cord	68.1040.5000	6,0	6,0	6,0	m	130
For additional hoops add						
Base profile	77.4601.0000	3,6	3,4	3,1	m	90
Filling profile	77.6602.0000	4,0	4,0	4,0	m	50
Decoration profile	77.6500.xxxx	4,0	4,0	4,0	m	200
Centre hinge	77.3412.0000	2	2	2	PCS	100
Hinge bolt	66.6202.0000	2	2	2	PCS	100
Fixed corner 25 mm	77.3404.0000	2	-	-	PCS	50
Fixed corner 100 mm	77.3406.0000	-	2	-	PCS	10
Fixed corner 250 mm	77.3408.0000	-	-	2	PCS	10
Cord guide, single	77.3433.0000	1	1	1	PCS	5
Cord wheel	78.0092.0000	1	1	1	PCS	20
For interior cord operation add						
Cord guide	77.7210.0001	2	2	2	PCS	10
Cord inlet	77.7212.0000	2	2	2	PCS	10

Bill of material: Arista type B with cord operation

Projection: 800 mm
Width: 2000 mm
Number of hoops: 3 + 1

Description	Colour	Qty			Unit	Stand. Pack [Unit]
		Model B25	Model B100	Model B250		
Base profile	77.4601.0000	14,2	13,6	12,7	m	90
Filling profile	77.6602.0000	16,0	16,0	16,0	m	50
Decoration profile	77.6500.xxxx	16,0	16,0	16,0	m	200
Installation bracket	77.3402.0000	3	3	3	PCS	50
Screw for installation	66.1203.0000	3	3	3	PCS	100
Hinge 3 canopy hoops	77.3453.0000	2	2	2	PCS	10
Hinge 1 canopy hoops	77.3450.0000	1	1	1	PCS	10
Fixed corner 25 mm	77.3404.0000	8	-	-	PCS	50
Fixed corner 100 mm	77.3406.0000	-	8	-	PCS	10
Fixed corner 250 mm	77.3408.0000	-	-	8	PCS	10
Cord guide, single	77.3433.0000	3	3	3	PCS	5
Cord wheel	78.0092.0000	2	2	2	PCS	20
Fixing plate for cord wheel	77.7216.0000	1	1	1	PCS	10
Cord cleat	77.3304.0000	1	1	1	PCS	25
Tassel	71.2301.0058	1	1	1	PCS	100
Cord	68.1040.5000	8,0	8,0	8,0	m	130
For additional hoops add						
Base profile	77.4601.0000	3,6	3,4	3,1	m	90
Filling profile	77.6602.0000	4,0	4,0	4,0	m	50
Decoration profile	77.6500.xxxx	4,0	4,0	4,0	m	200
Centre hinge	77.3412.0000	2	2	2	PCS	100
Hinge bolt	66.6202.0000	2	2	2	PCS	100
Fixed corner 25 mm	77.3404.0000	2	-	-	PCS	50
Fixed corner 100 mm	77.3406.0000	-	2	-	PCS	10
Fixed corner 250 mm	77.3408.0000	-	-	2	PCS	10
Cord guide, single	77.3433.0000	1	1	1	PCS	5
Cord wheel	78.0092.0000	1	1	1	PCS	20
For interior cord operation add						
Cord guide	77.7210.0001	2	2	2	PCS	10
Cord inlet	77.7212.0000	2	2	2	PCS	10

Arista models

Type A

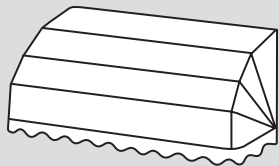

A25

- Classic - small radius
- 25 mm corner radius
- Projection equal to height
- Retractable or fixed

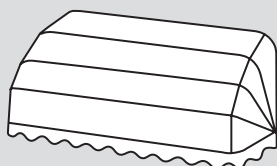

A100

- Classic - medium radius
- 100 mm corner radius
- Projection equal to height
- Retractable or fixed

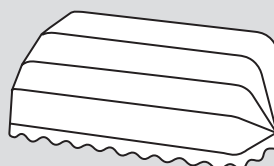

A250

- Classic - large radius
- 250 mm corner radius
- Projection equal to height
- Retractable or fixed

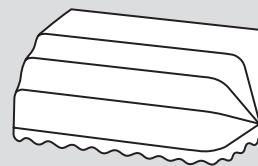

A1

- Classic - combination
- Wall hoop has smaller radius than the other hoops
- Projection equal to height
- Retractable or fixed

Type B

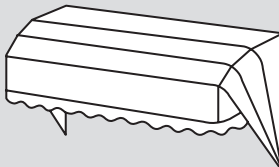

B25

- Stepped canopy - small radius
- 25 mm corner radius
- Projection less than height
- Retractable or fixed

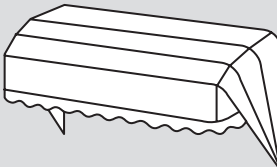

B100

- Stepped canopy - medium radius
- 100 mm corner radius
- Projection less than height
- Retractable or fixed

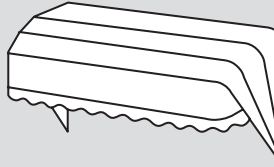

B250

- Stepped canopy - large radius
- 250 mm corner radius
- Projection less than height
- Retractable or fixed

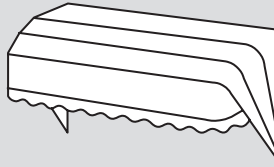

B1

- Stepped canopy - combination
- Wall hoop has smaller radius than the other hoops
- Projection less than height
- Retractable or fixed

Type C

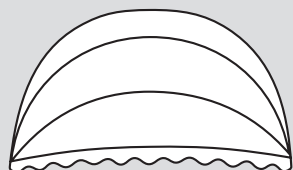

C1

- Round canopy
- Width equal to twice the projection
- Retractable or fixed

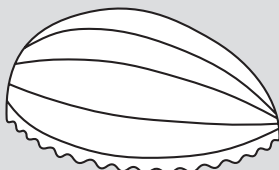

C2

- Curved canopy
- Width more than twice the projection
- Retractable or fixed

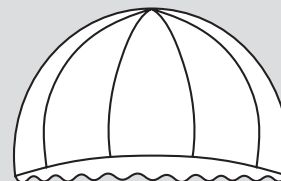

C3

- Cupola canopy
- Vertical hoops
- Fixed

Type D

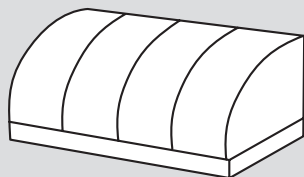

D1

- Cylindrical canopy
- Vertical hoops
- Fixed

Type E

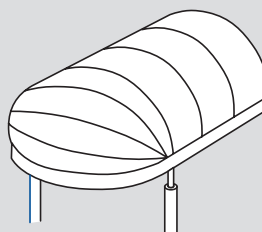

E1

- Walkway canopy - curved
- Curved front
- Fixed

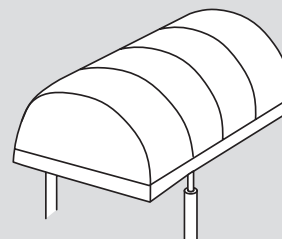

E2

- Walkway canopy - flat
- Flat front
- Fixed

HUNTER DOUGLAS SCANDINAVIA

PO Box 541
SE-441 15 Alingsås
Sweden
Tel: +46-322 775 00
Fax: +46-322 775 99
E-mail: order@hunterdouglas.se

HunterDouglas 

www.hunterdouglas.se